

# PRINCIPAL PARTICULARS

LENGTH (O.A.) : 36.00 m  
 LENGTH (B.P.) : 33.20 m  
 BREADTH (MLD.) : 7.60 m  
 DEPTH (MLD.) : 3.65 m  
 DESIGNED DRAUGHT : 1.88 m  
 COMPLEMENT : 8 CREWS

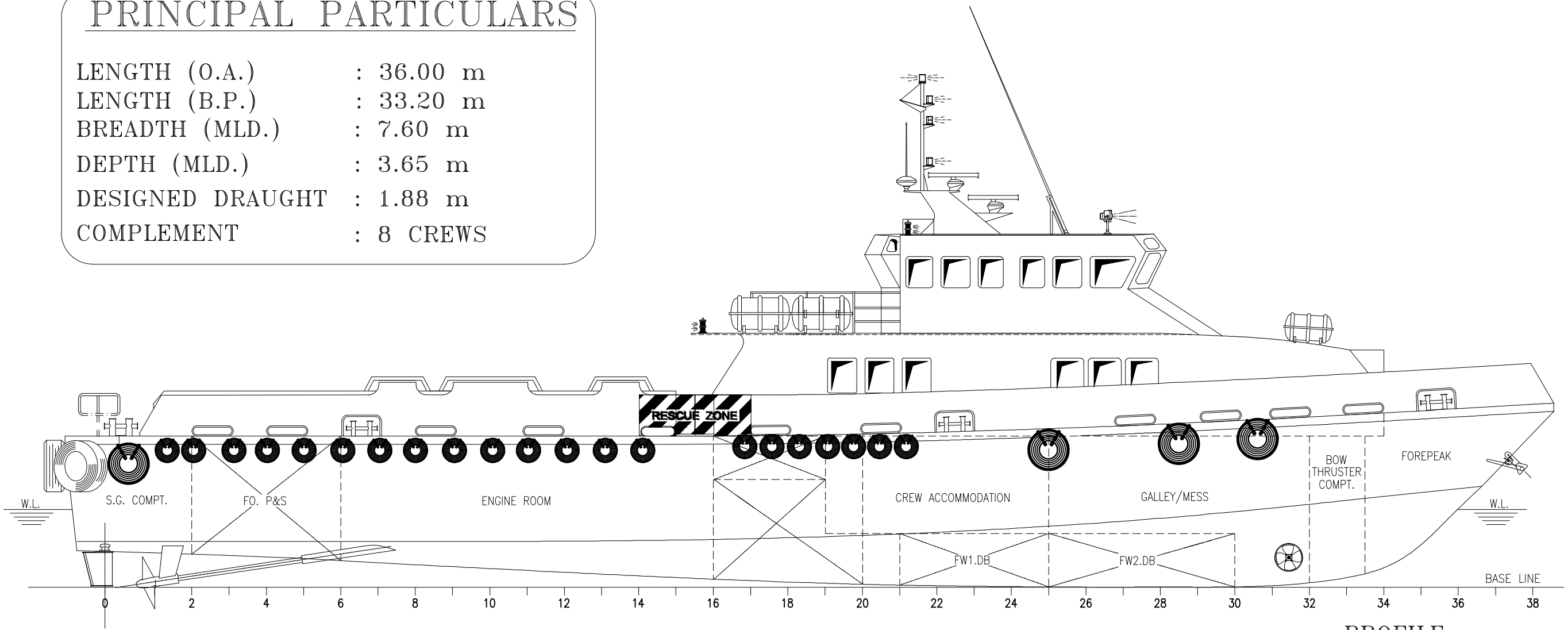

PROFILE

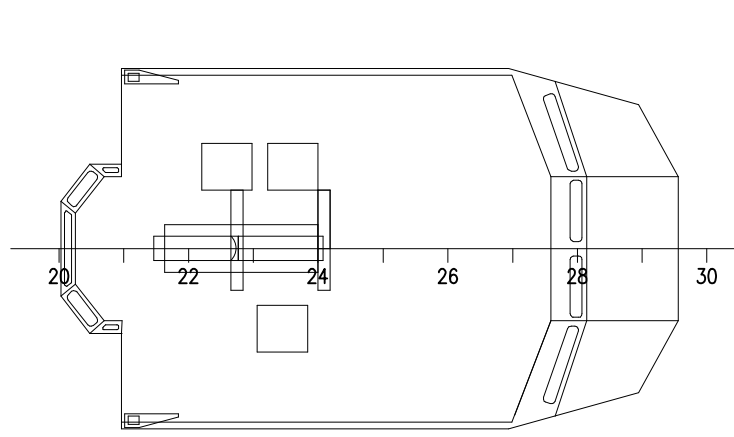

WHEELHOUSE TOP

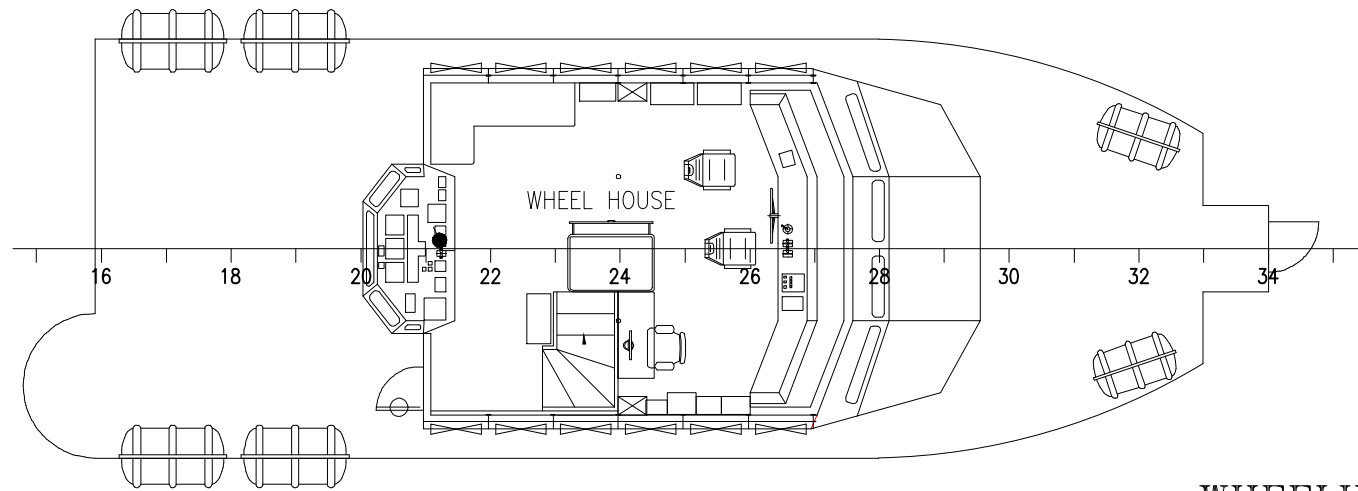

WHEELHOUSE

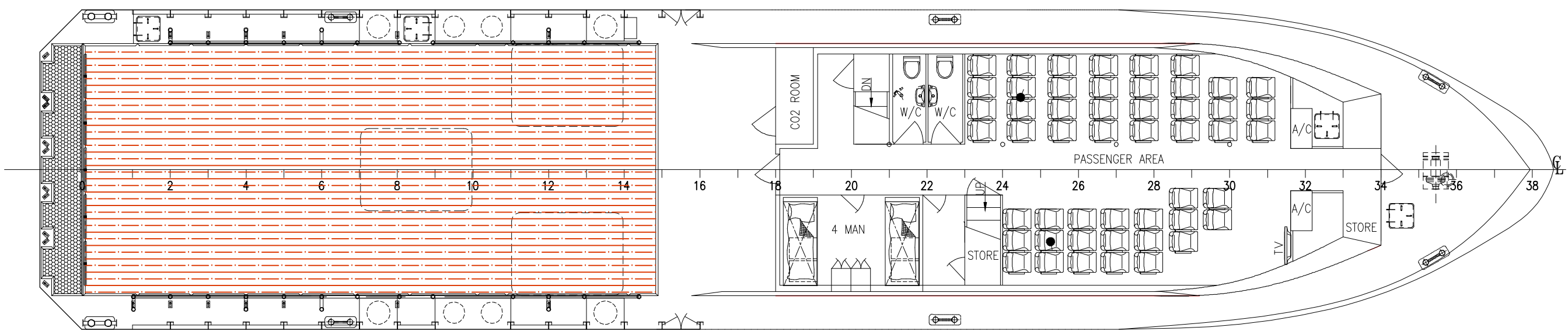

MAIN DECK

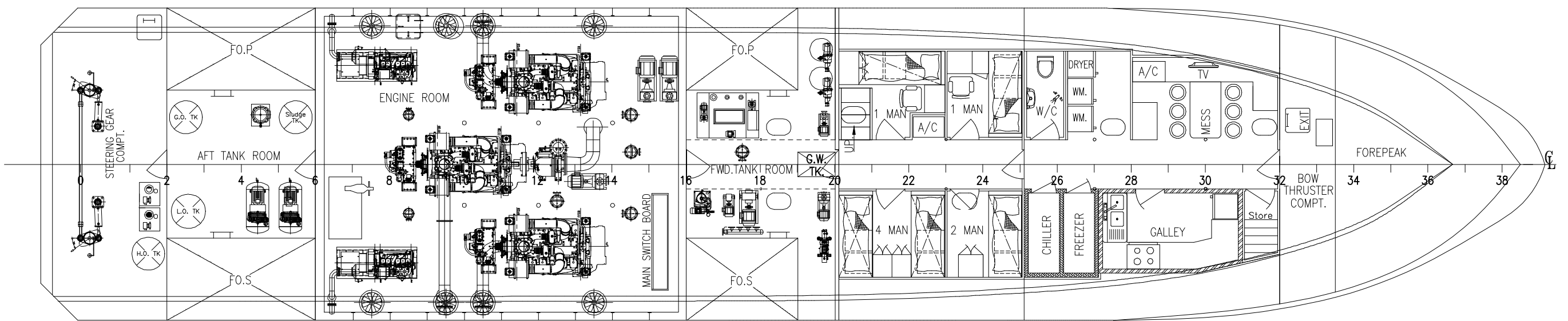

BELOW MAIN DECK

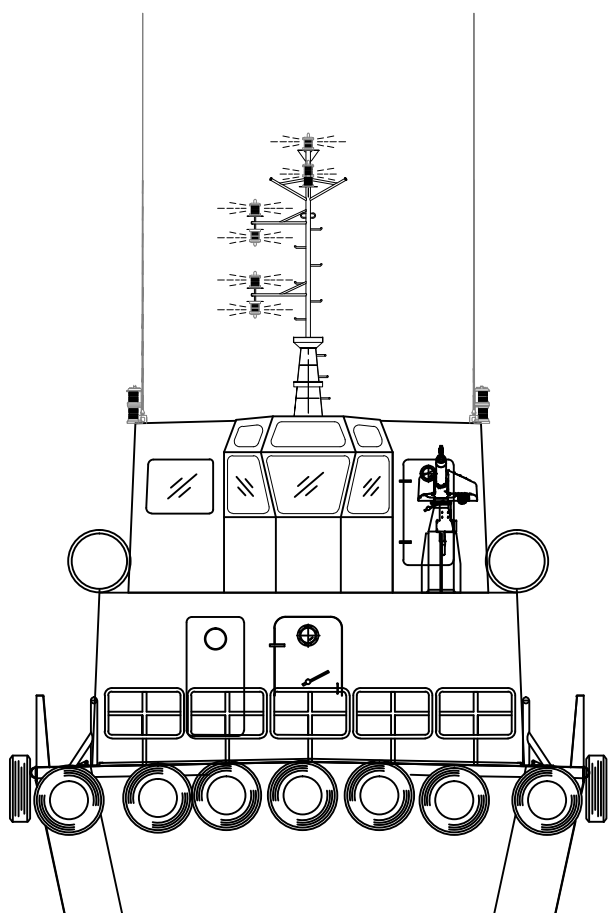

STERN VIEW

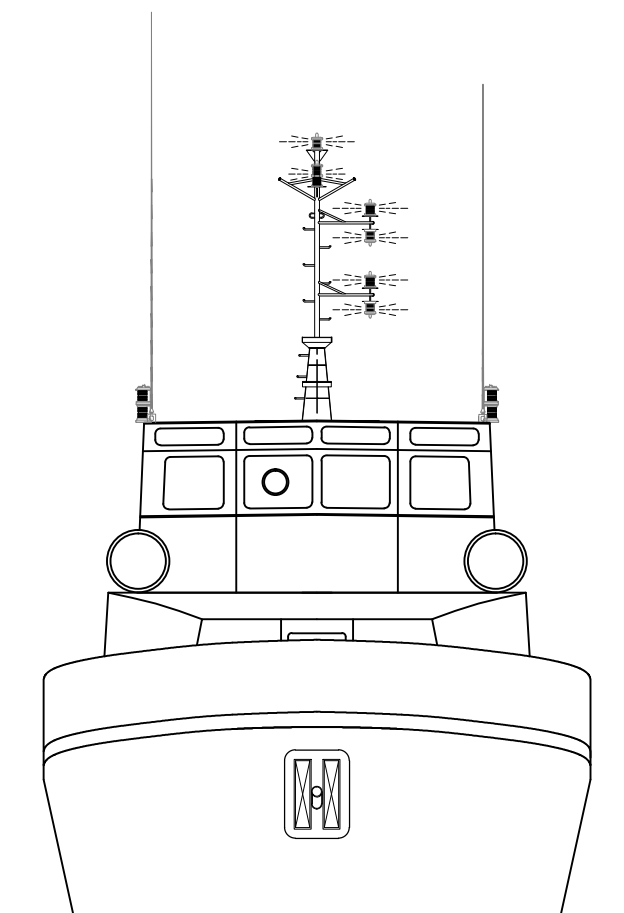

FRONT VIEW

REVISED AS PER CLIENT COMMENTS	B	IJR	DCF	12.SEP.16
REVISED AS PER CLIENT COMMENTS (DN8610/201)	A	SM	GM	06.DEC.12
DESCRIPTION	REV	DRN BY	CHK BY	DATE

CLIENT:  
**MICLYN EXPRESS OFFSHORE**

	TITLE : GENERAL ARRANGEMENT PLAN		
	SHIP NAME : EXPRESS 67		
CONTRACT NO.:	DRAWING NO.:		GEN001
DRAWN: IJR	REV.NO.: B	SCALE: 1:100	
CHECKED: DCF	SHEET NO.: 1 OF 1		SIZE: A2

Main Office (Singapore) : No.3 Harbour Front Place, #11 -01/04 Harbour Front Tower 2  
 Singapore 099254  
 Tel: (65) 65456211 Fax: (65) 62756212  
[www.miclynexpressoffshore.com](http://www.miclynexpressoffshore.com)  
 This document contains Confidential Proprietary information and shall not be Copied, Reproduced, Used, Transferred to other Documents or Disclosed to others for any purpose unless Authorized by MEO.

APPROVED: EBEN TAN  
 DATE: 12-SEPT-2016